

JOTA

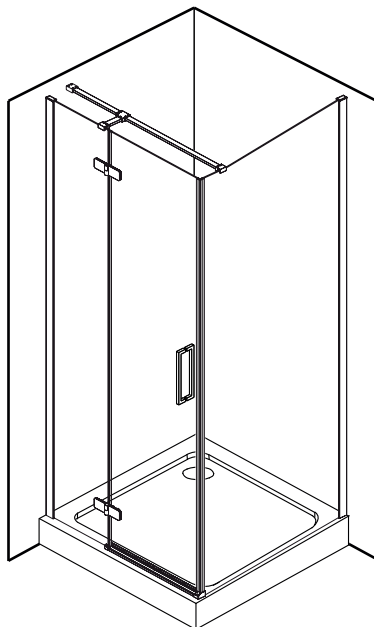

PL INSTRUKCJA MONTAŻU I EKSPLOATACJI

CZ NÁVOD NA MONTÁŽ A ÚDRŽBU

SK NÁVOD NA MONTÁŽ A ÚDRŽBU

EST PAIGALDUS- JA KASUTUSJUHEND

LT MONTAVIMO IR EKSPLOATAVIMO INSTRUKCIJA

LV MONTĀŽAS UN EKSPLUATĀCIJAS INSTRUKCIJA

DE MONTAGE- UND AUFBAUANLEITUNG

RO INSTRUCȚIUNI DE MONTAJ ȘI OPERARE

HU SZERELÉSI ÉS ÜZEMELTETÉSI ÚTMUTATÓ

UA ІНСТРУКЦІЯ З МОНТАЖУ І ЕКСПЛУАТАЦІЇ

BY ІНСТРУКЦЫЯ ПА МАНТАЖЫ І ЭКСПЛУАТАЦЫІ

RU ИНСТРУКЦИЯ ПО МОНТАЖУ И ЭКСПЛУАТАЦИИ

EN INSTRUCTIONS FOR ASSEMBLY AND USE

FR INSTALLATION ET UTILISATION - MODE

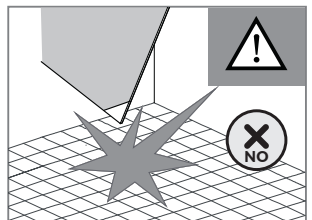
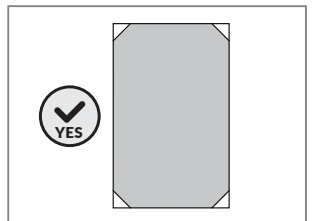
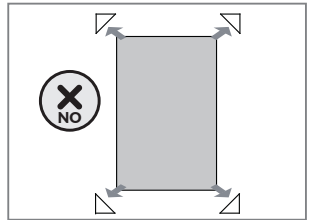
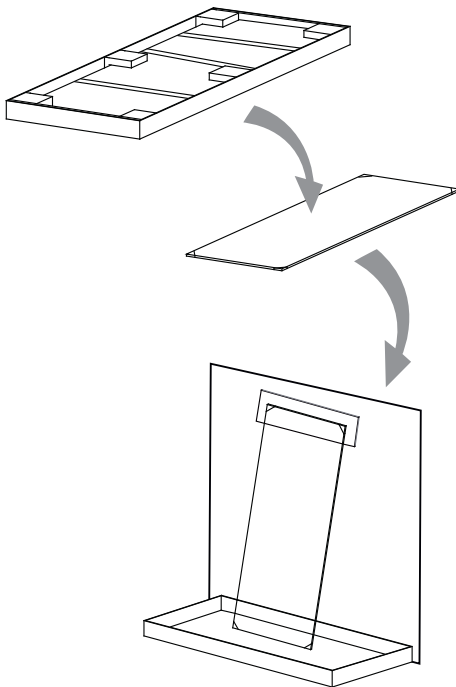
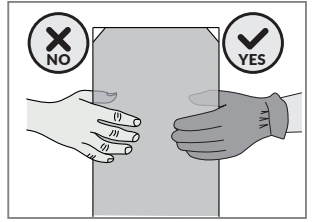
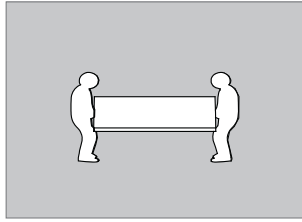
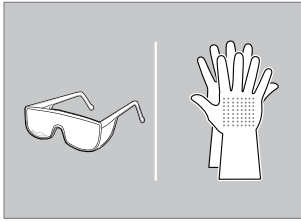
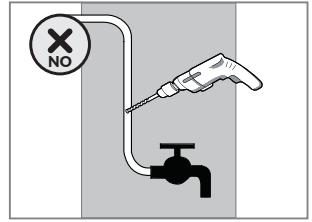
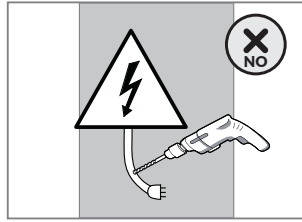
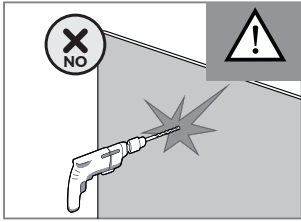

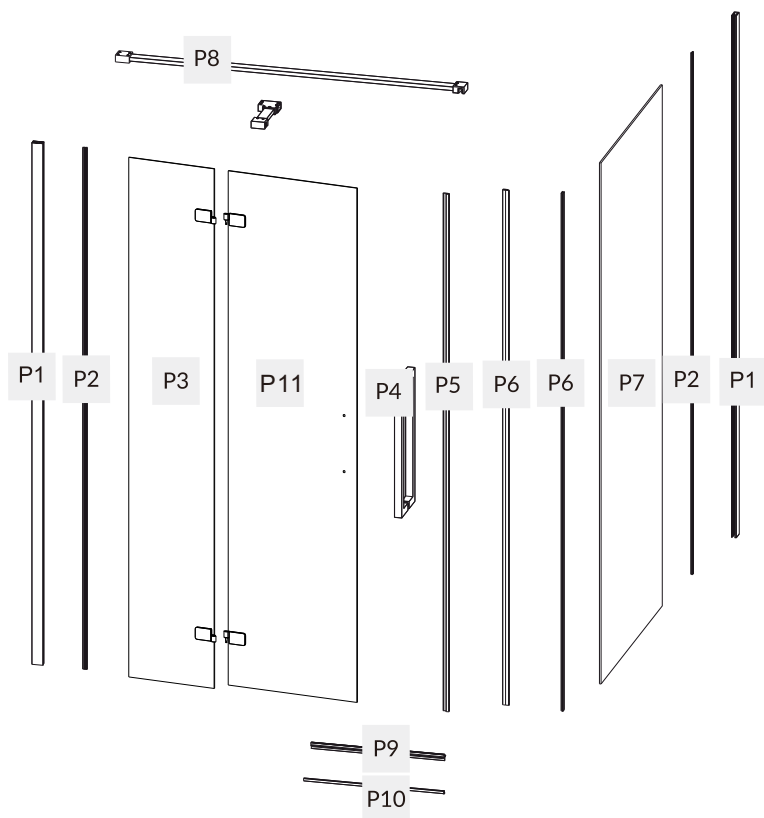

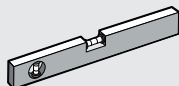
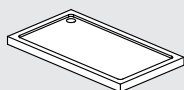
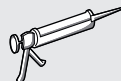
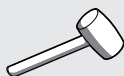
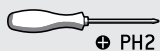
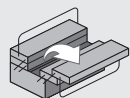
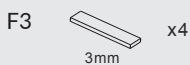
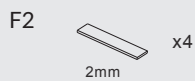
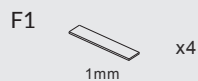
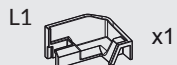
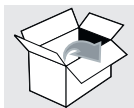

1.

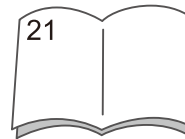
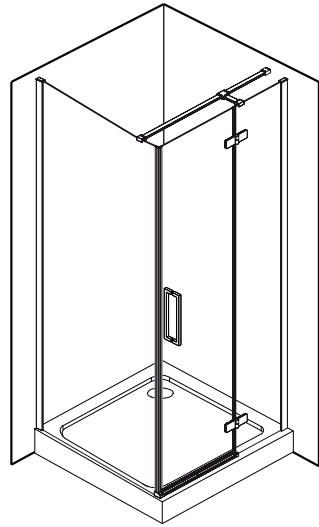
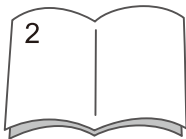
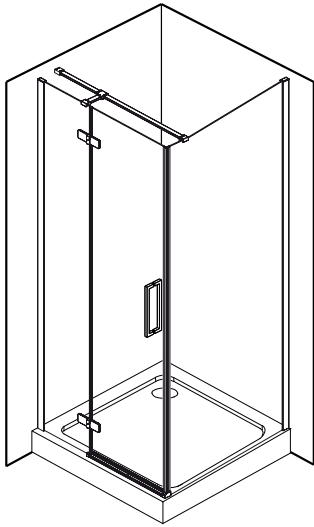

2.

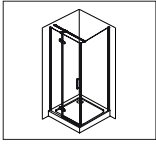

SIZE	X (mm)	Y (mm)
900X900X1950	890-900	890-900

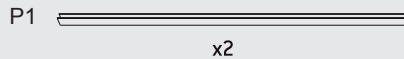
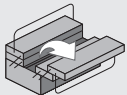
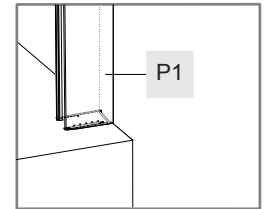
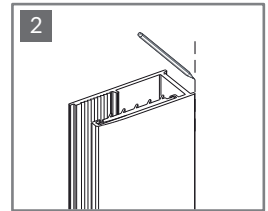
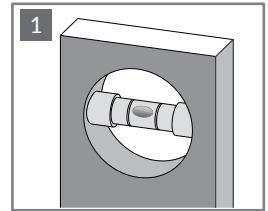
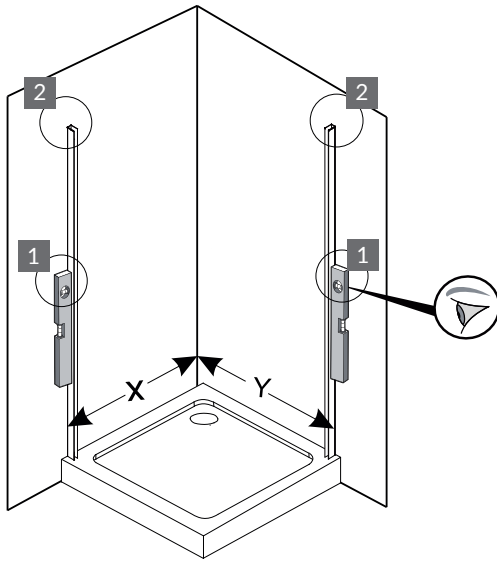

3.

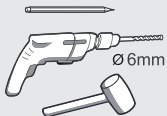
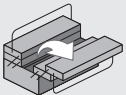
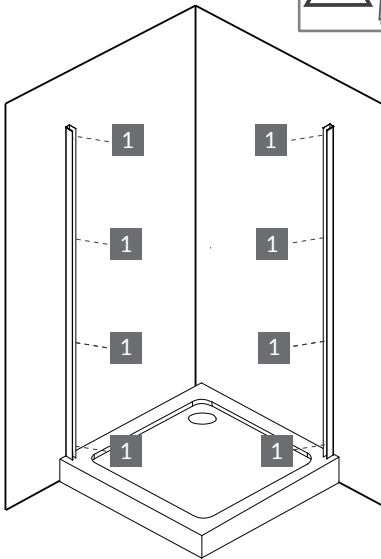
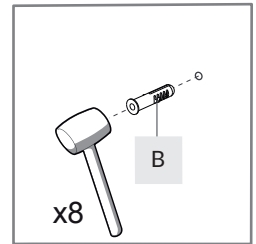
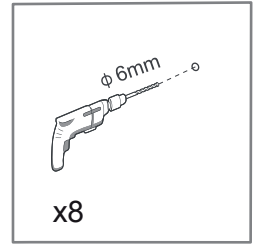
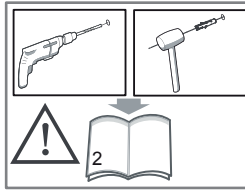
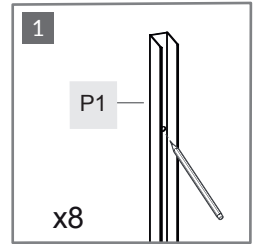
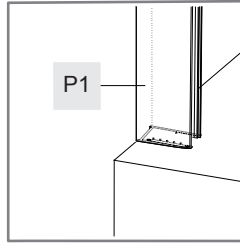
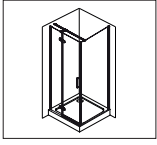

B



x8



4.

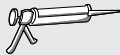
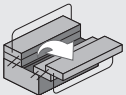
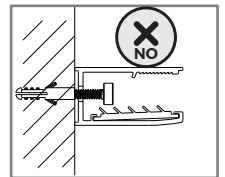
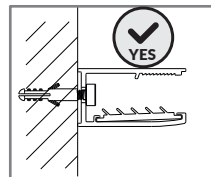
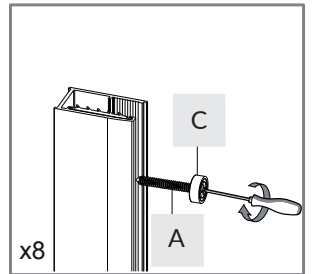
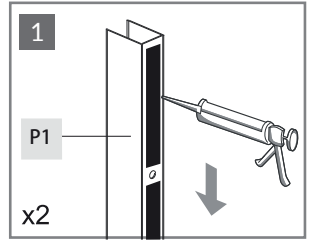
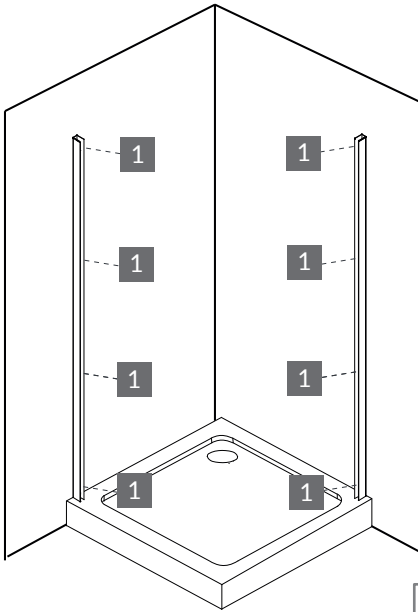
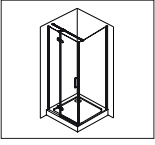

P1



x2

C



x8

A



x8



5.

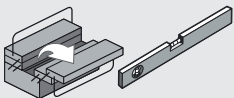
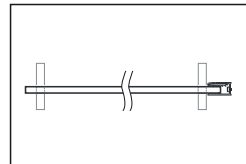
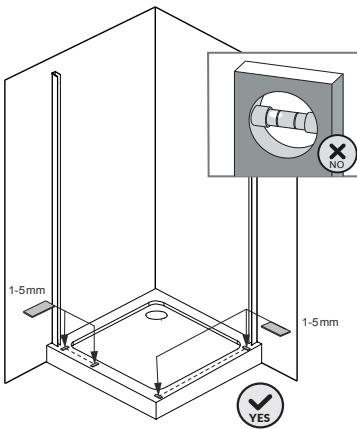
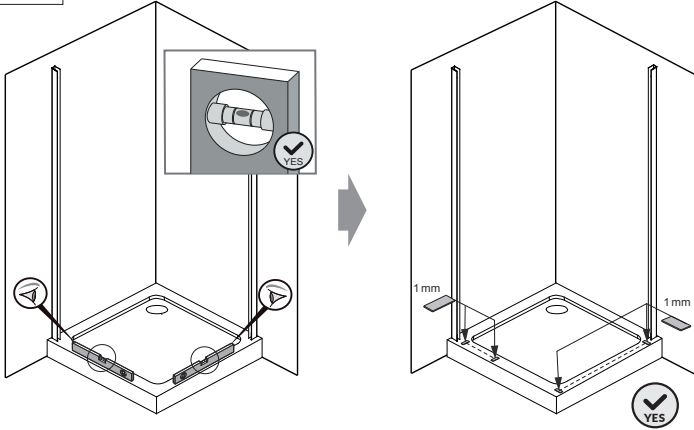
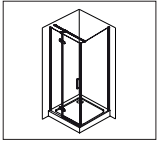

F1



x4

F2



x4

F3



x4



6.

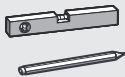
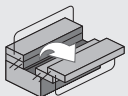
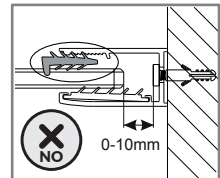
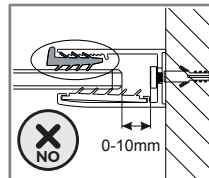
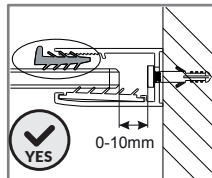
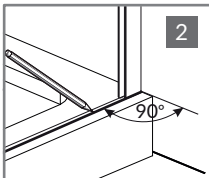
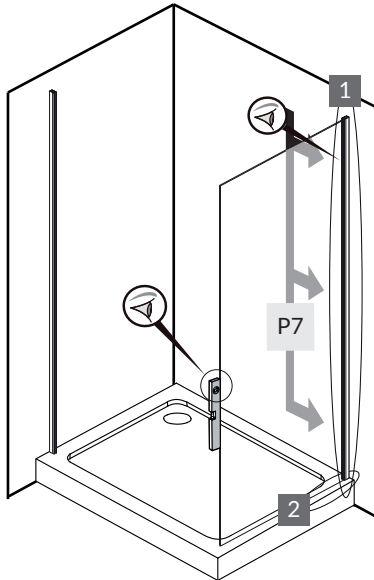
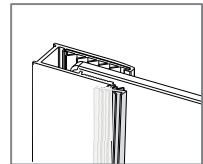
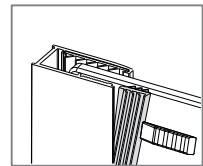
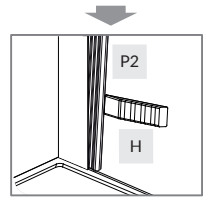
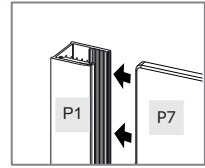
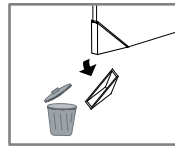
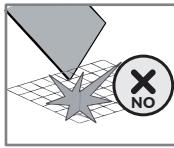
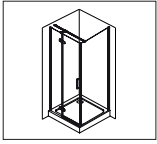

P2 —————

x1



x1



7.

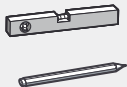
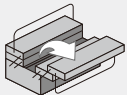
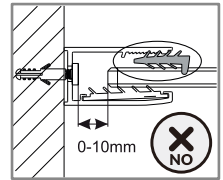
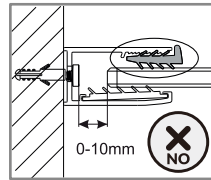
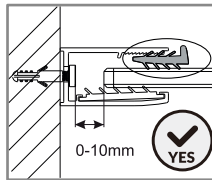
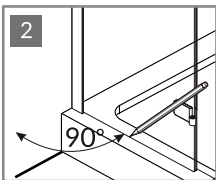
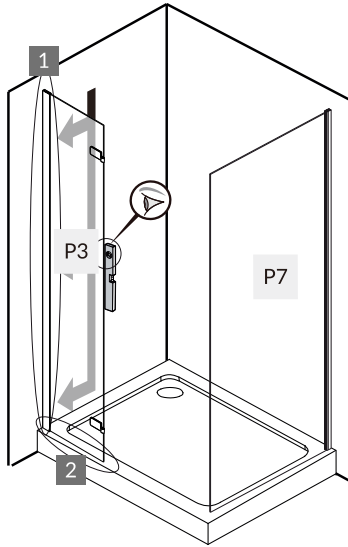
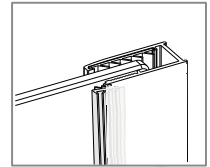
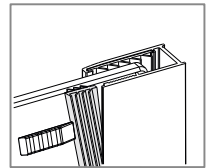
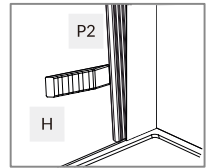
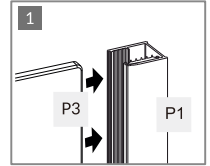
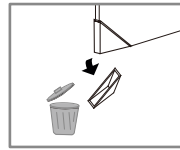
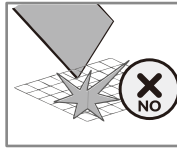
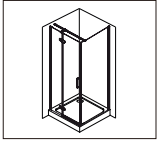

P2 ————— x1

H ————— x1



8.

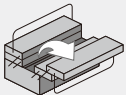
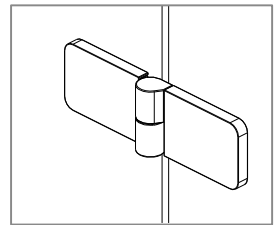
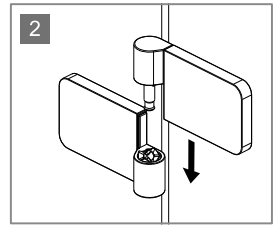
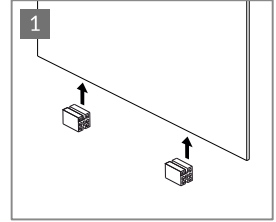
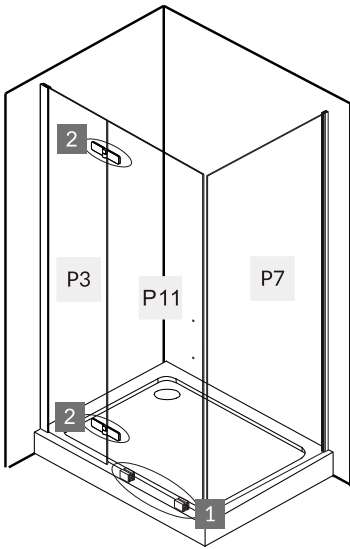
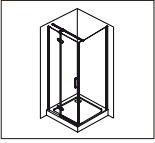

P11

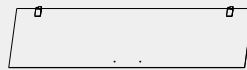

x1

N2



x2



9.

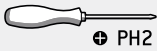
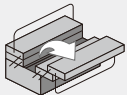
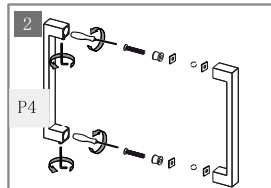
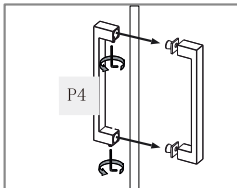
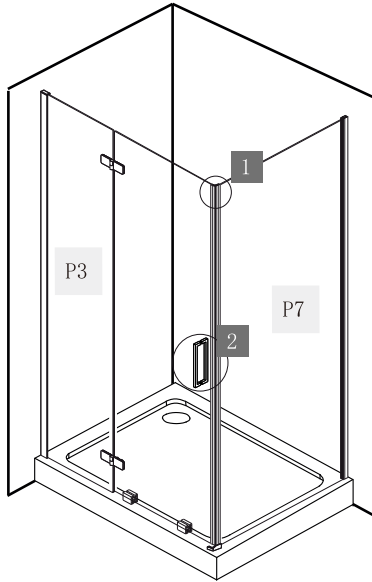
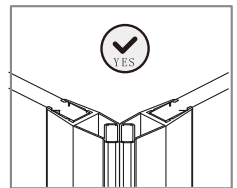
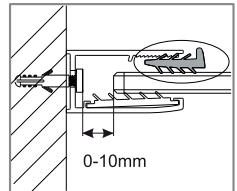
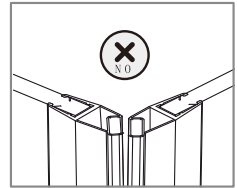
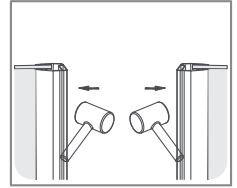
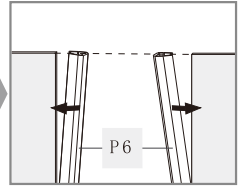
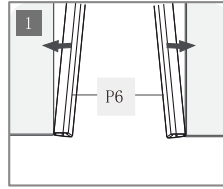
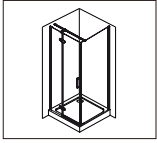

P6 ————— x2

P4 ————— x1



10.

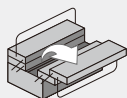
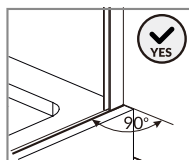
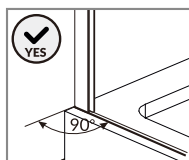
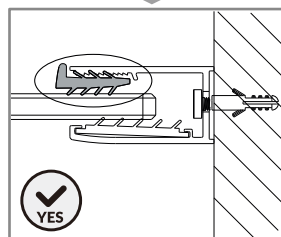
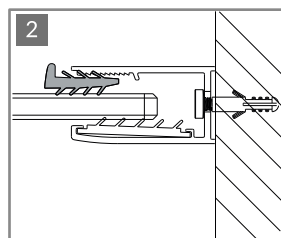
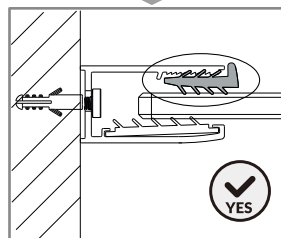
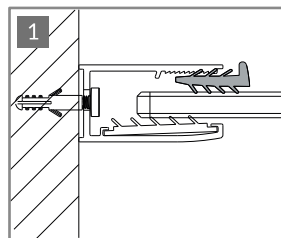
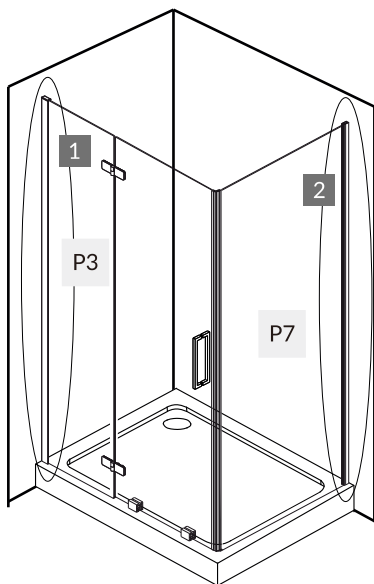
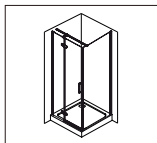

H



x1



11.

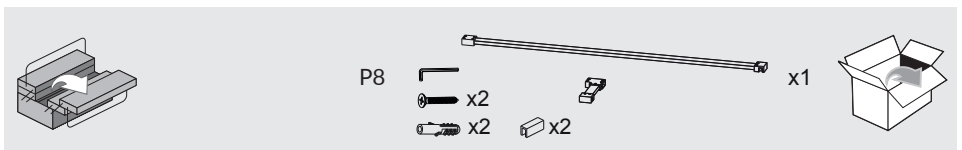
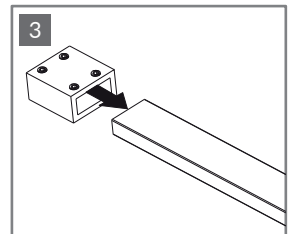
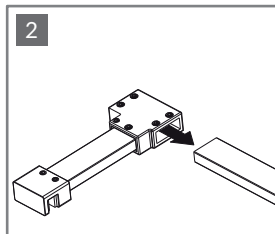
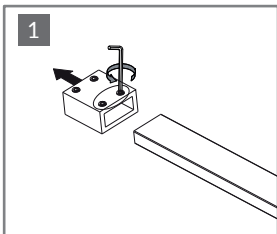
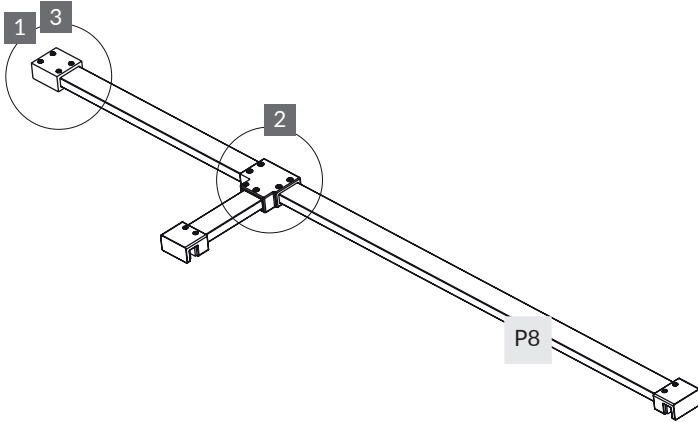
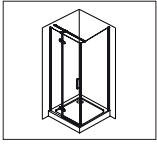

12.

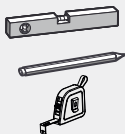
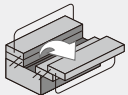
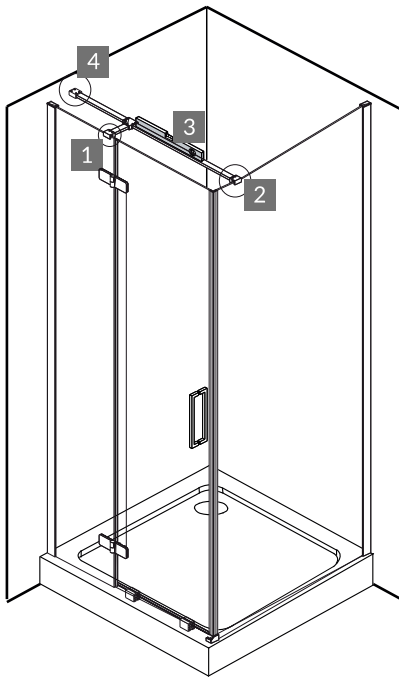
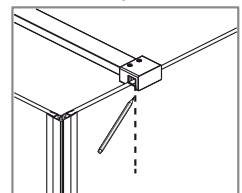
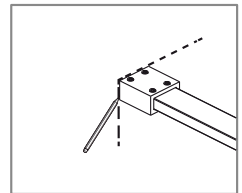
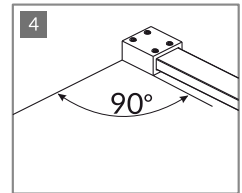
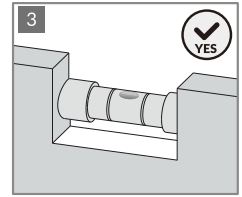
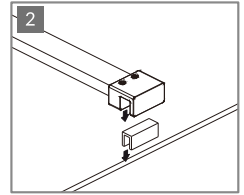
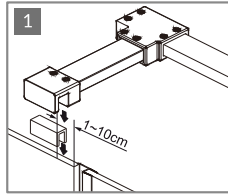
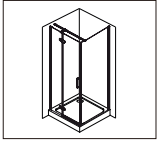

P8



x1

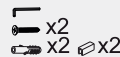

x2

x2

x2



13.

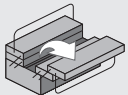
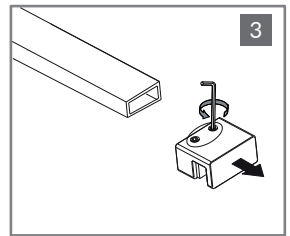
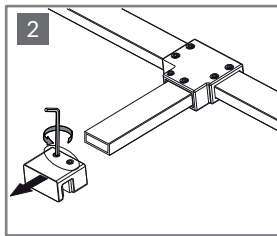
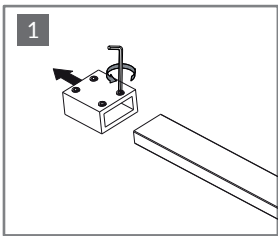
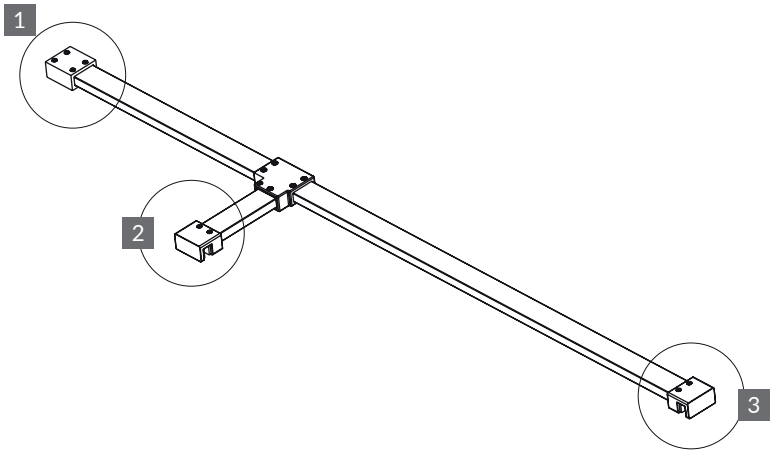
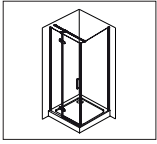

P8



x1

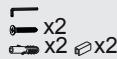

x2

x2 x2



14.

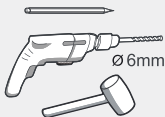
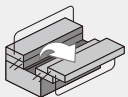
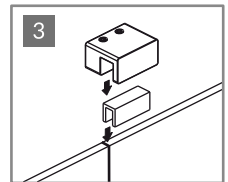
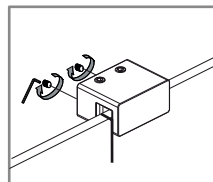
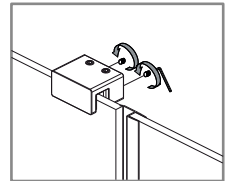
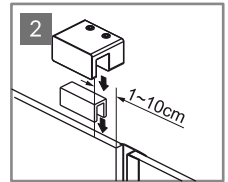
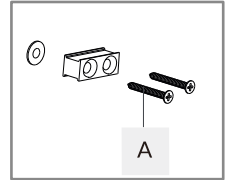
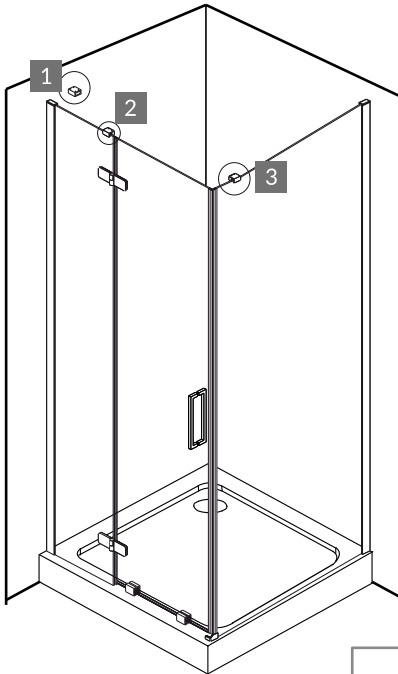
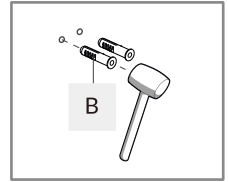
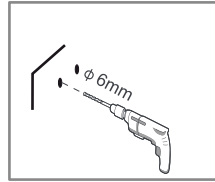
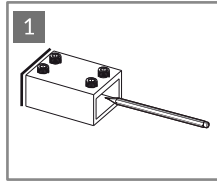
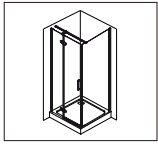

A  4x35 x2

B  x2



15.

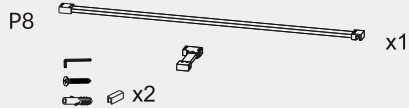
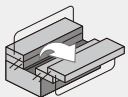
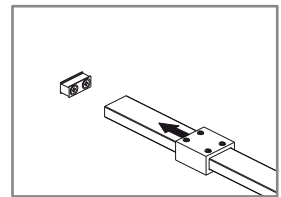
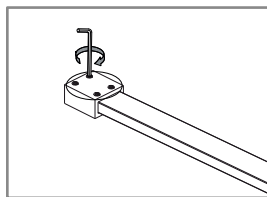
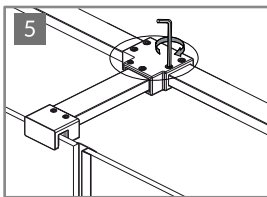
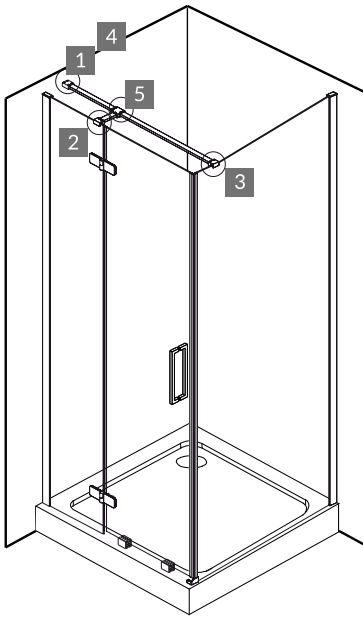
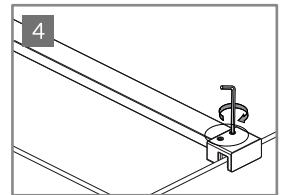
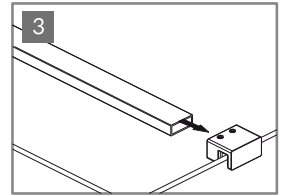
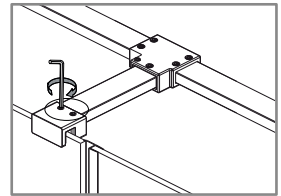
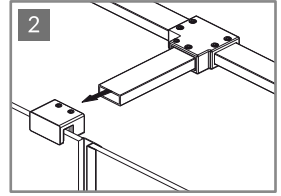
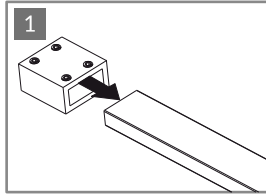
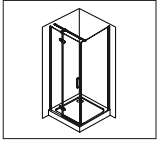

16.

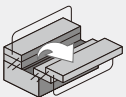
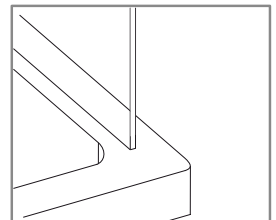
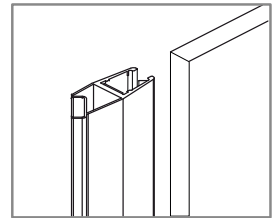
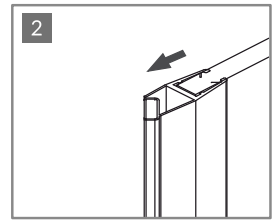
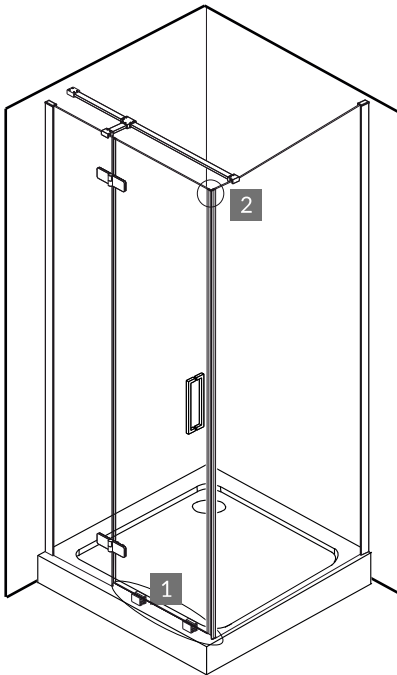
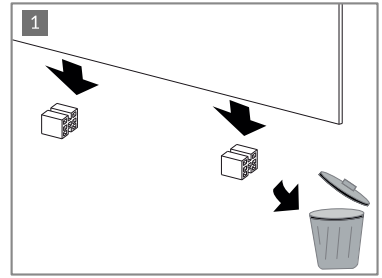
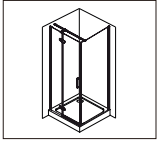

N2



x2



17.

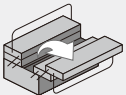
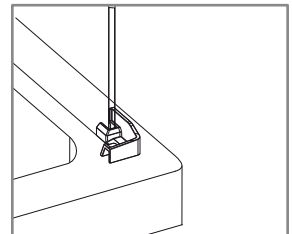
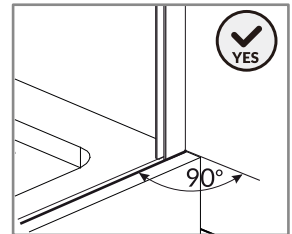
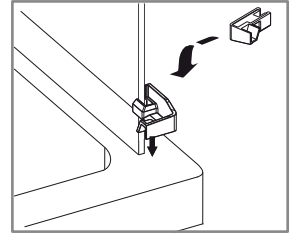
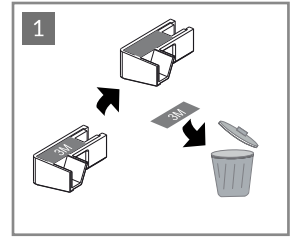
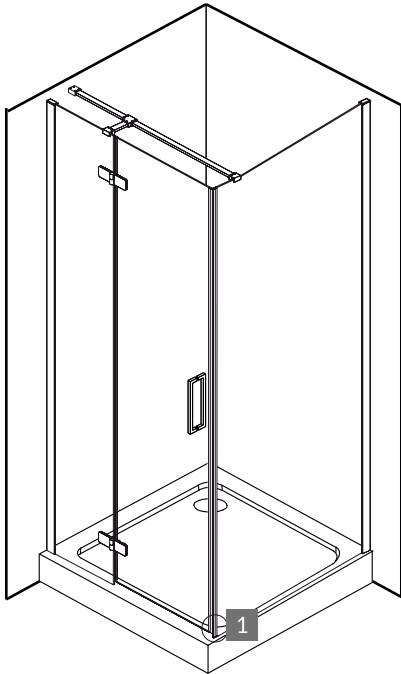
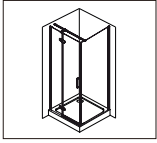

L1



x1



18.

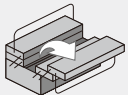
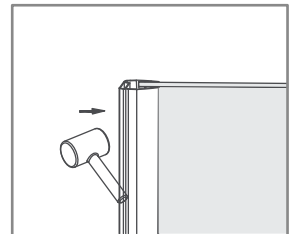
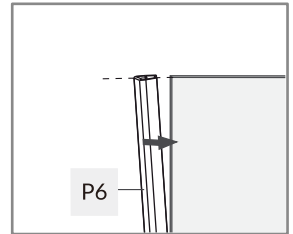
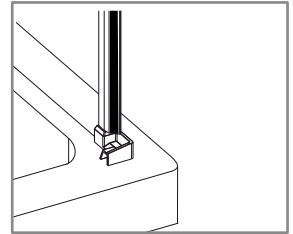
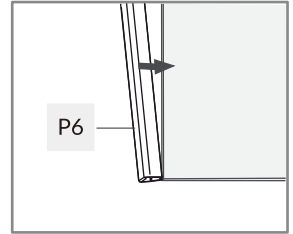
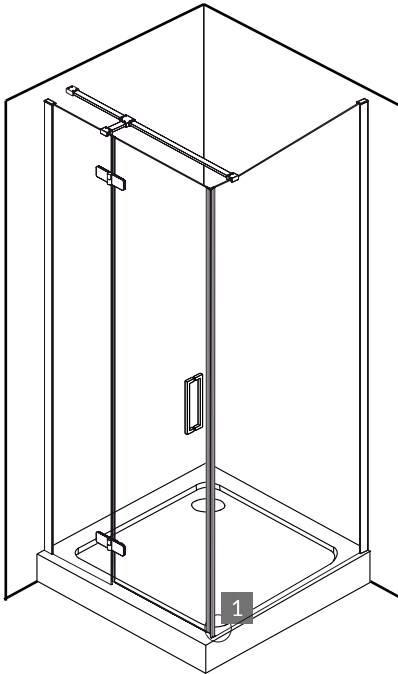
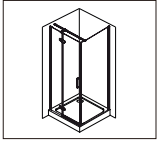

P6



x1



19.

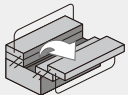
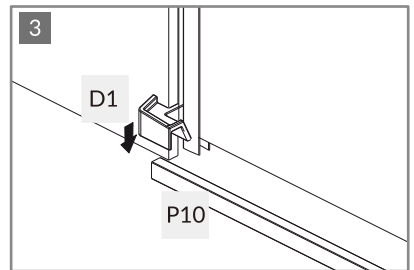
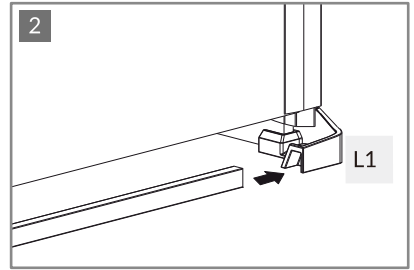
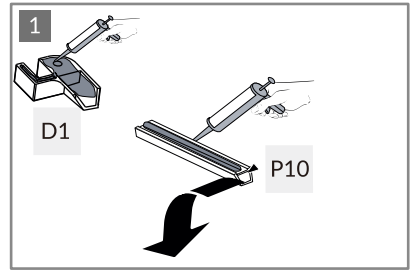
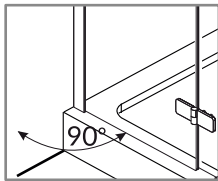
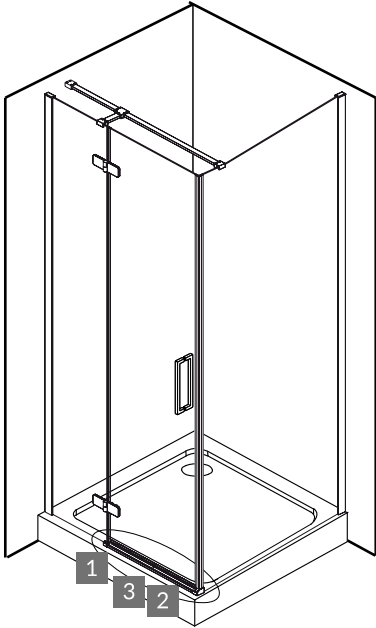
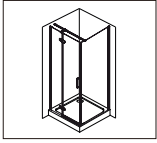

P10



x1

D1



x1



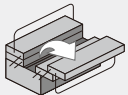
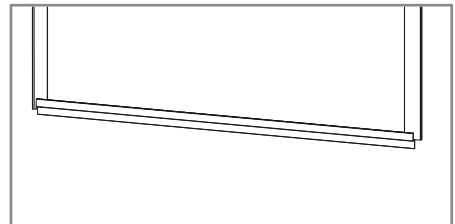
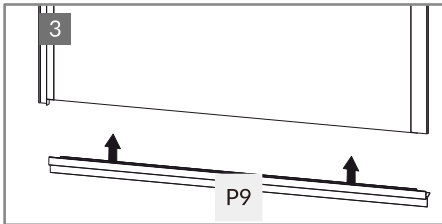
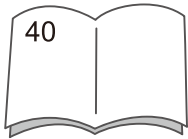
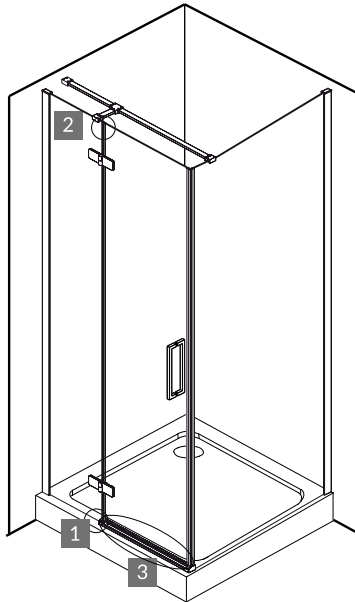
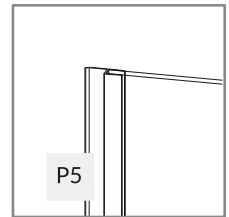
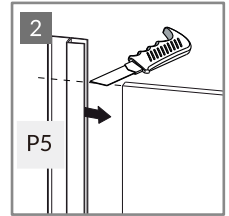
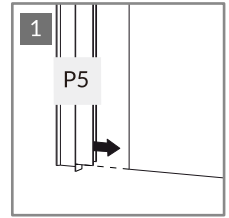
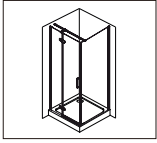

P5  x1

P9  x1



21.

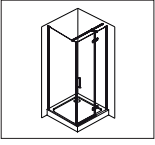

SIZE	X (mm)	Y (mm)
900X900X1950	890-900	890-900

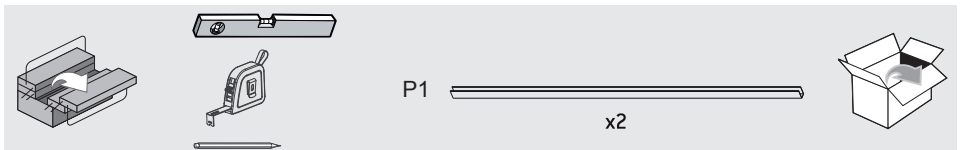
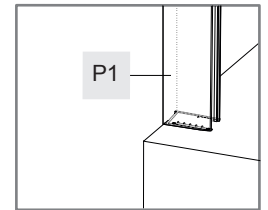
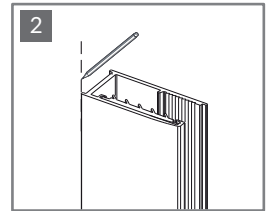
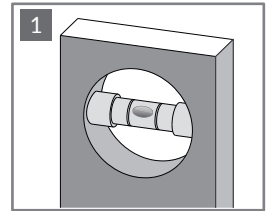
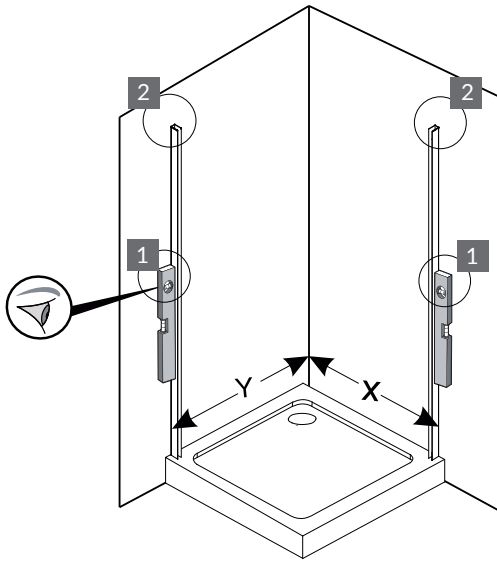

22.

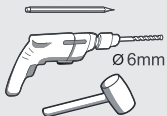
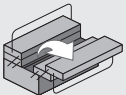
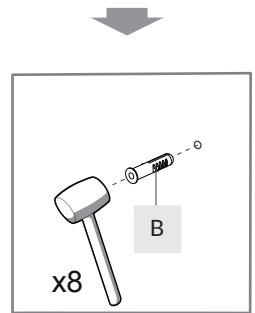
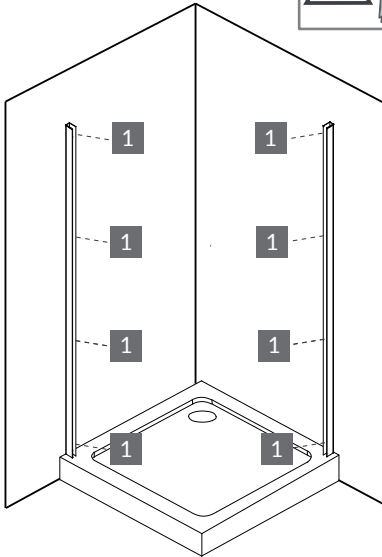
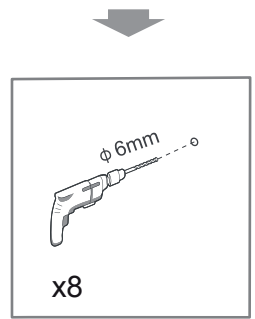
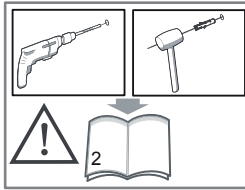
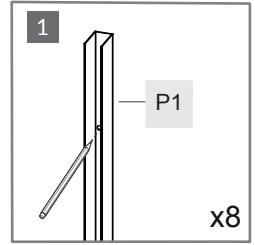
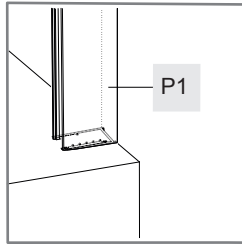
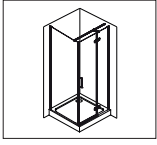

B



x8



23.

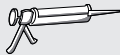
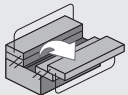
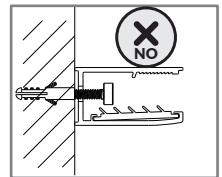
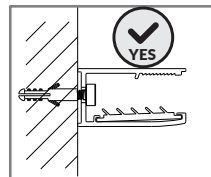
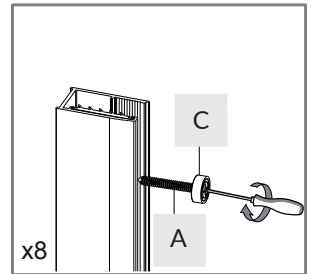
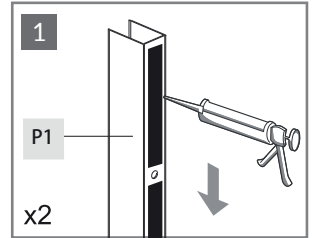
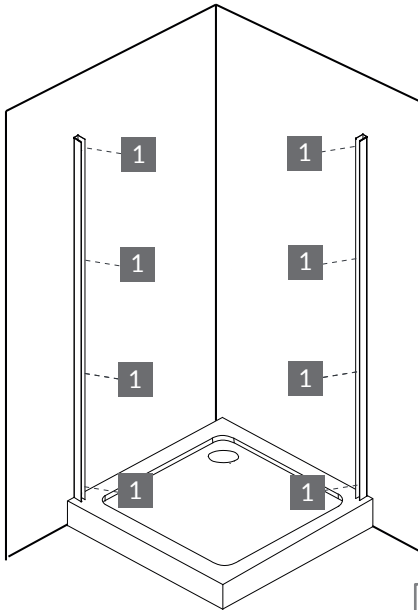
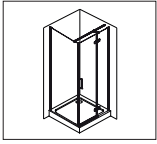

P1



x2



PH2

C



x8

A



4x35

x8



24.

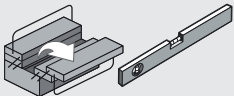
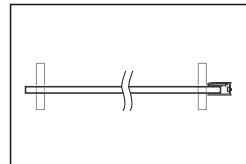
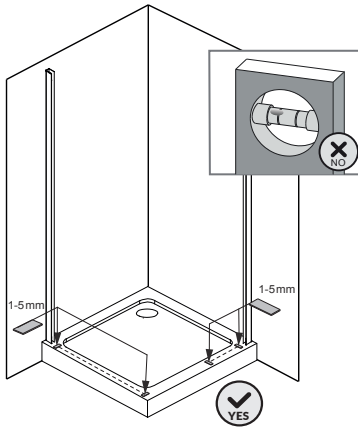
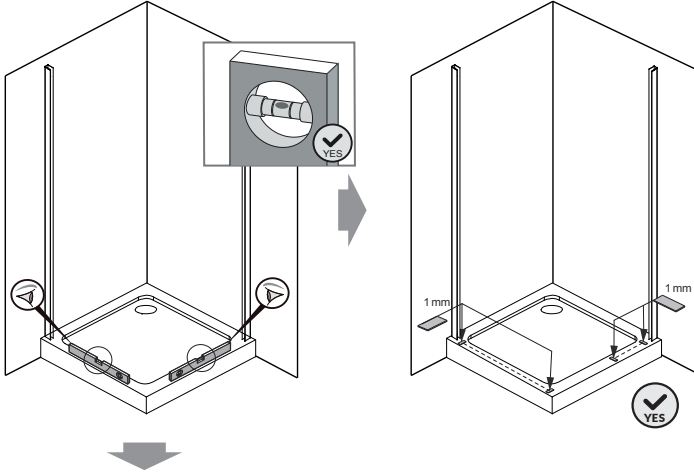
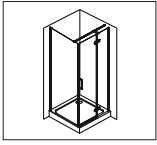

F1



x4

F2



x4

F3



x4



25.

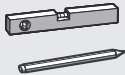
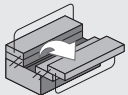
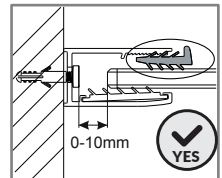
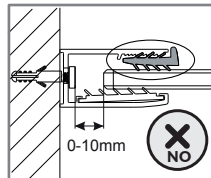
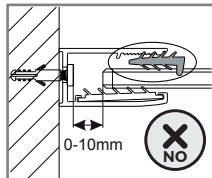
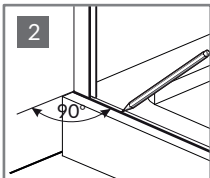
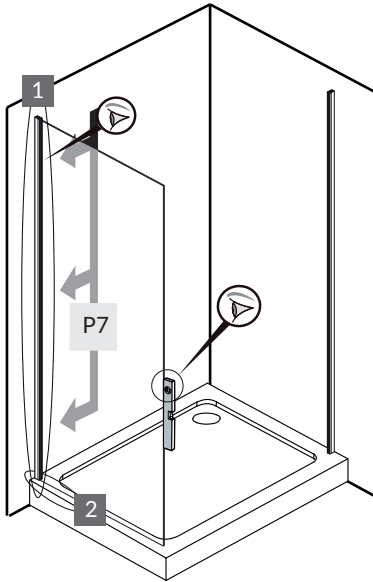
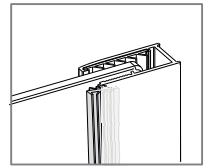
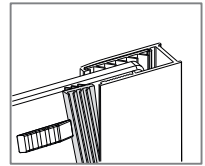
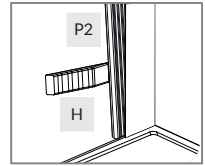
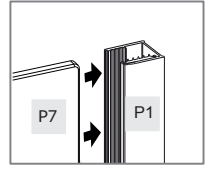
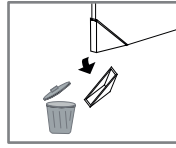
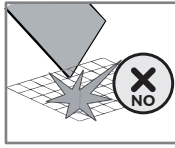
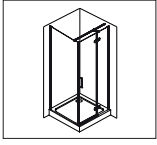

P2 —————

x1



x1



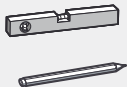
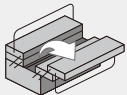
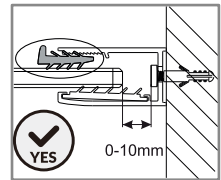
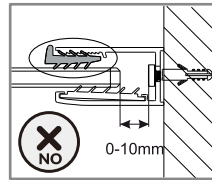
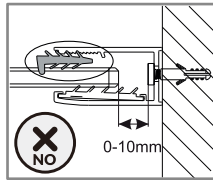
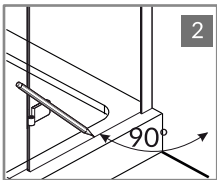
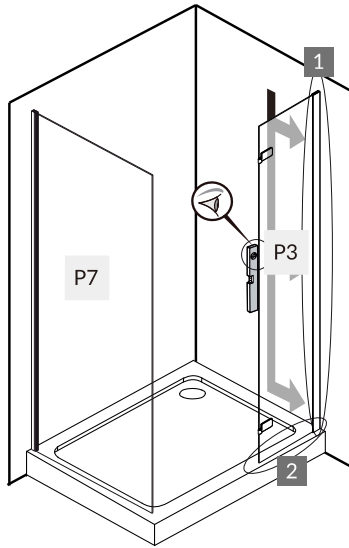
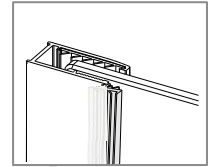
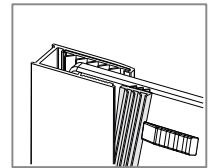
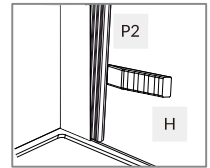
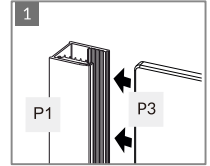
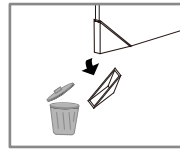
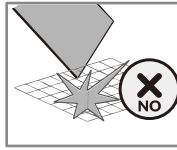
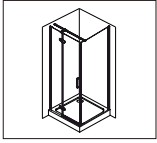

P2 ————— x1

H ————— x1



27.

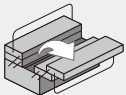
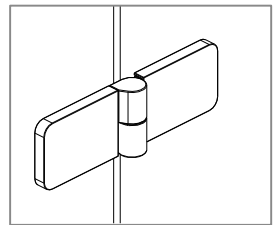
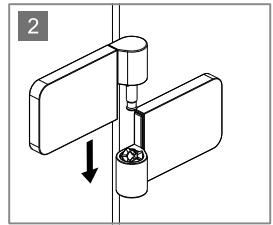
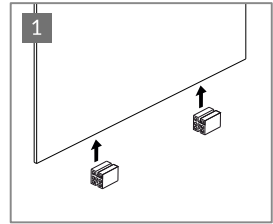
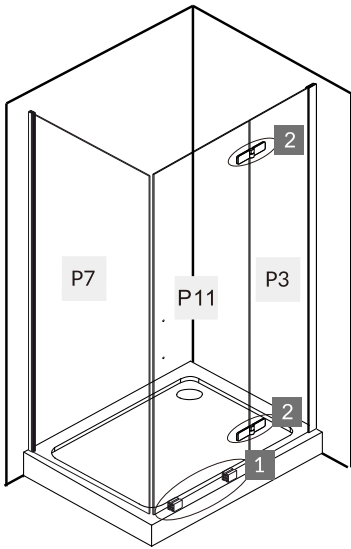
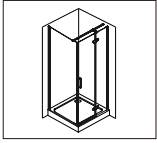

P11

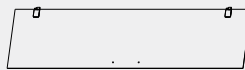

x1

N2



x2



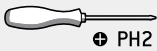
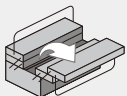
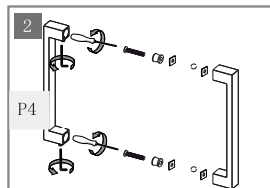
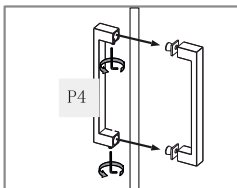
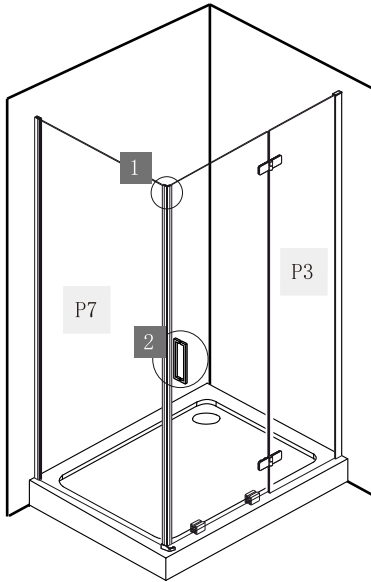
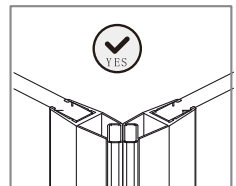
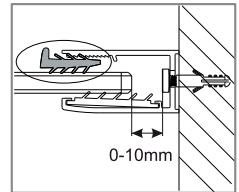
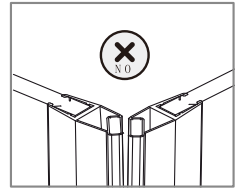
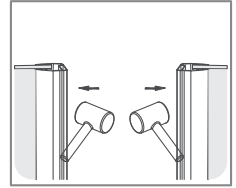
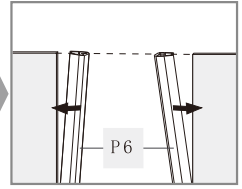
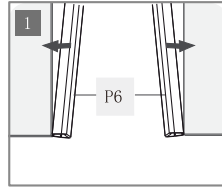
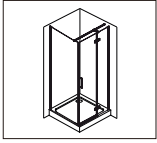

P6 ————— x2

P4 ————— x1



29.

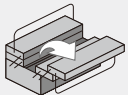
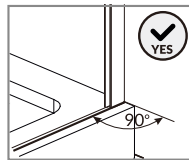
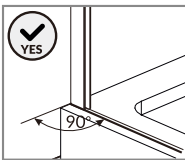
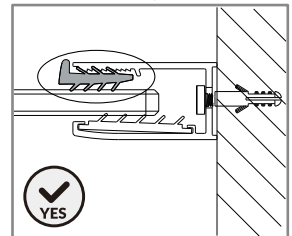
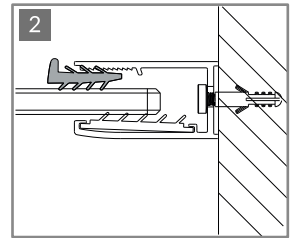
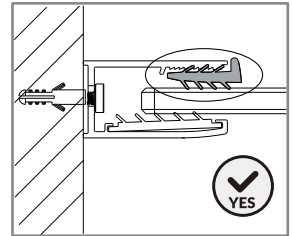
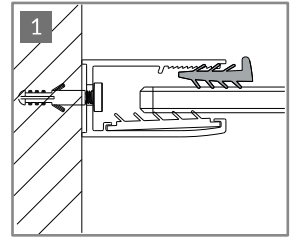
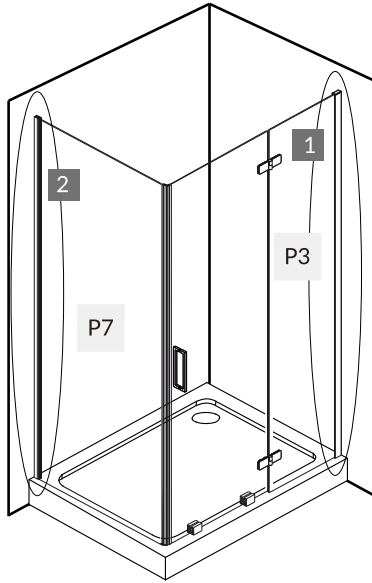
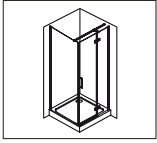

H



x1



30.

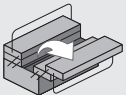
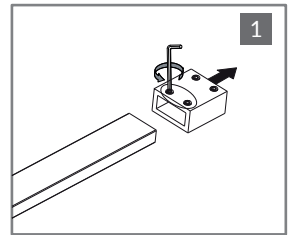
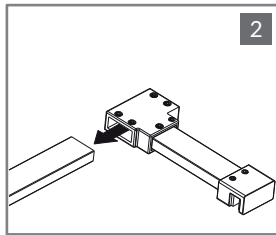
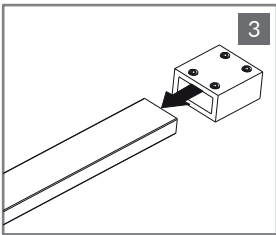
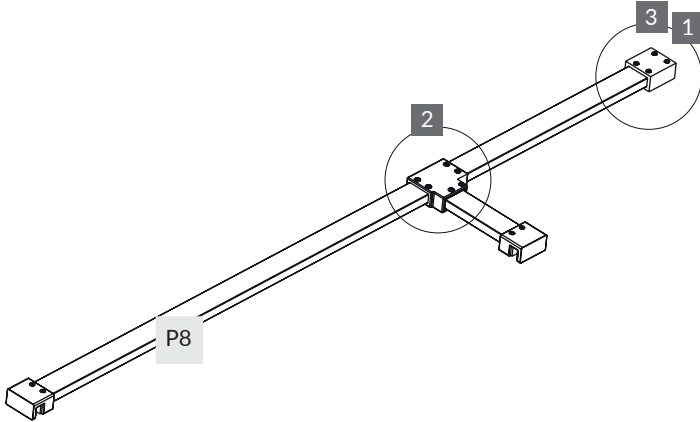
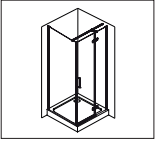

- P8
- x2
- x2
- x2
- x2
- x1



31.

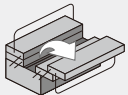
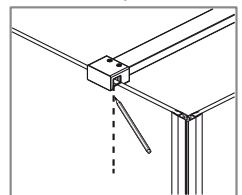
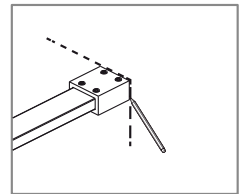
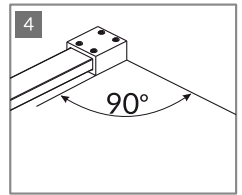
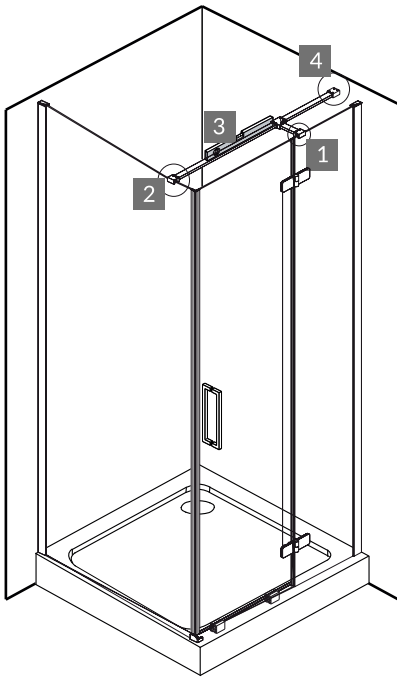
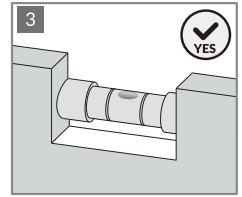
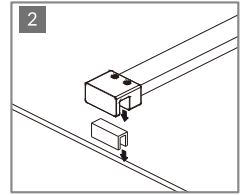
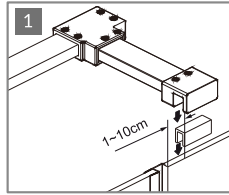
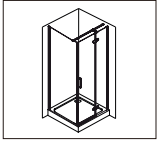

P8



x1

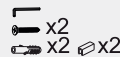

x2

x2 x2



32.

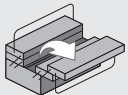
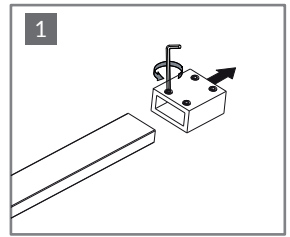
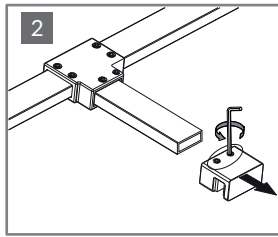
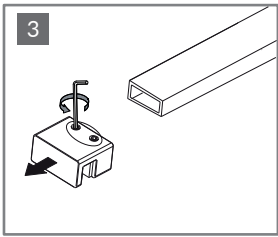
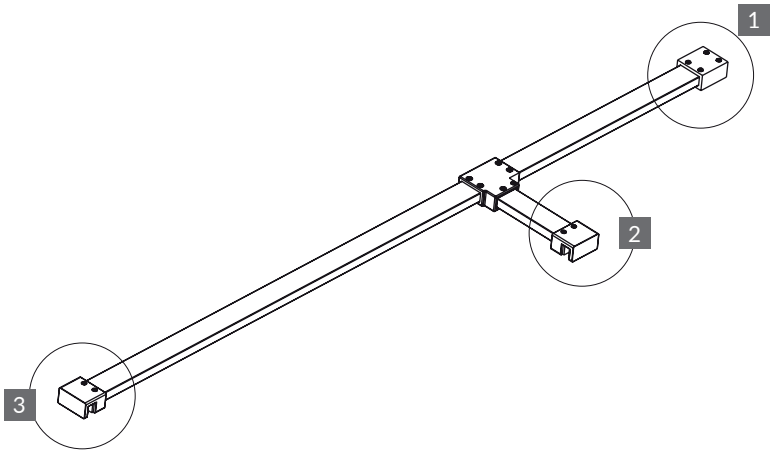
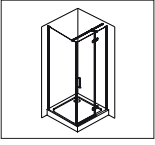

P8



x1

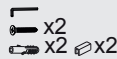

33.

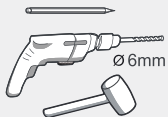
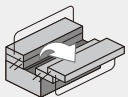
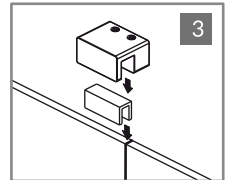
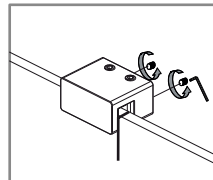
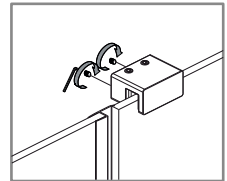
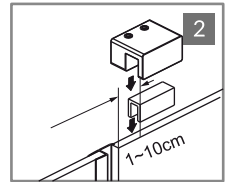
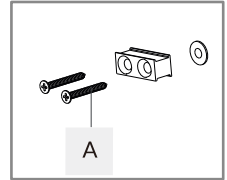
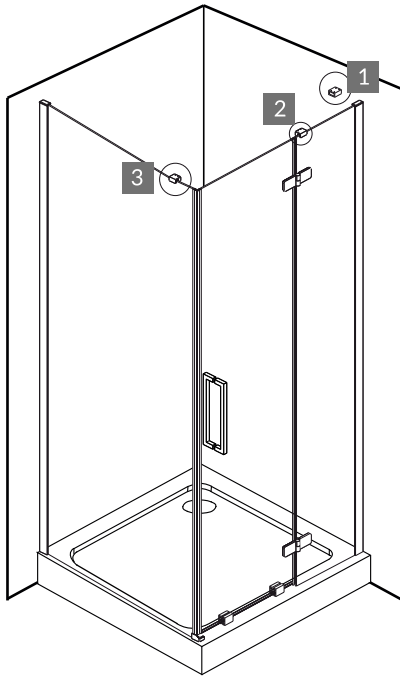
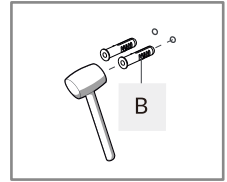
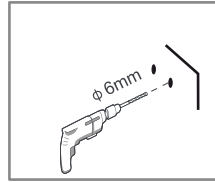
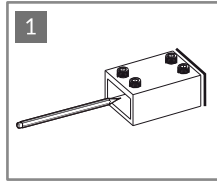
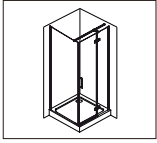

A  4x35 x2

B  x2



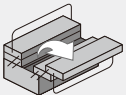
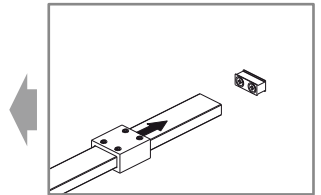
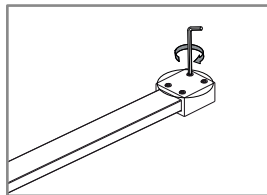
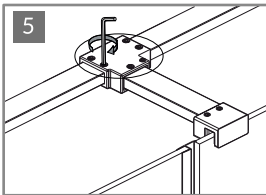
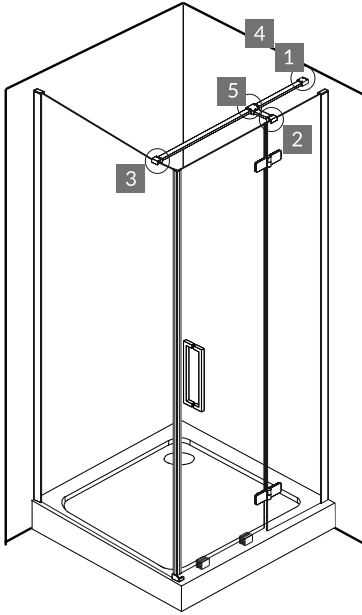
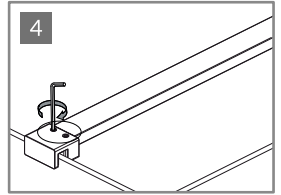
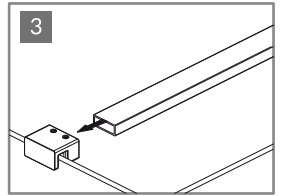
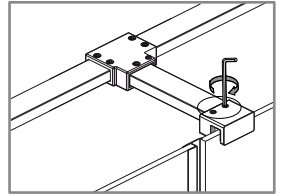
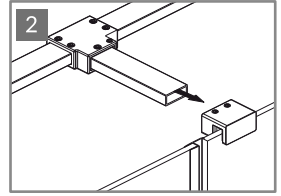
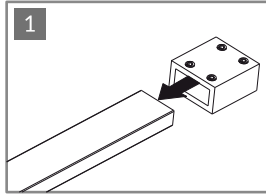
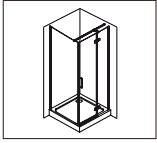

- P8 x1
- x1
- x2



35.

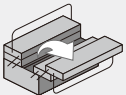
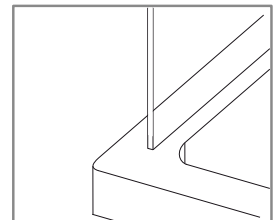
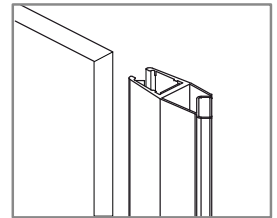
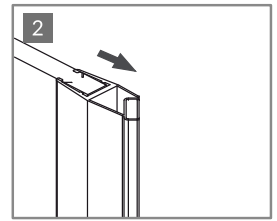
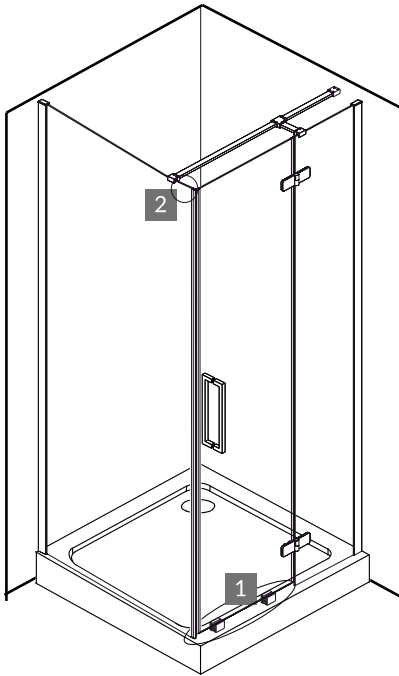
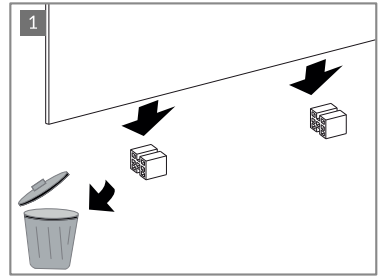
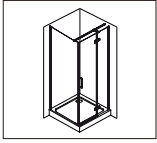

N2



x2



36.

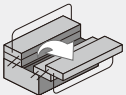
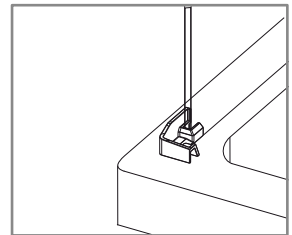
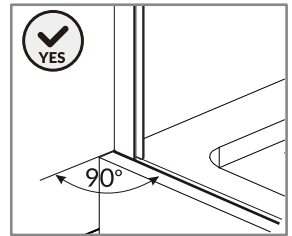
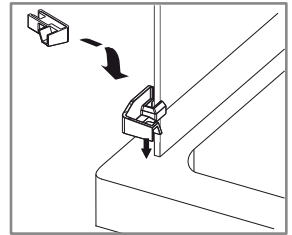
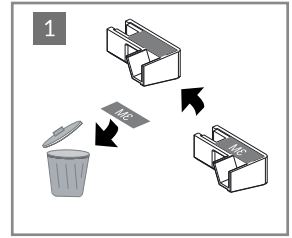
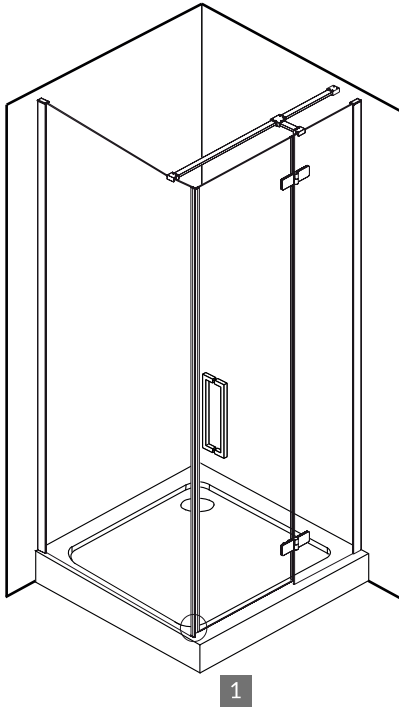
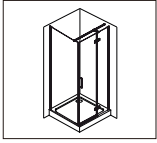

L2



x1



37.

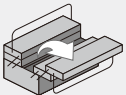
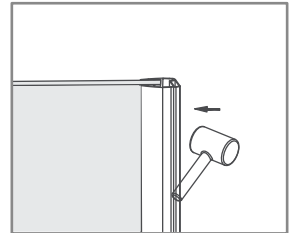
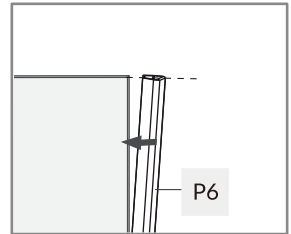
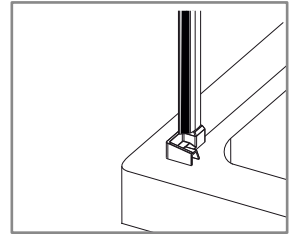
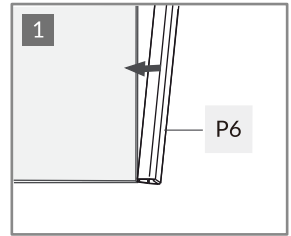
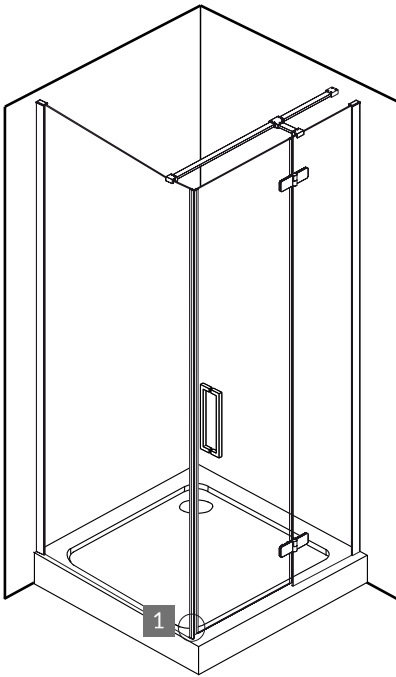
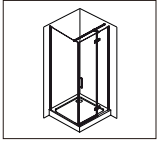

P6



x1



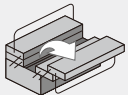
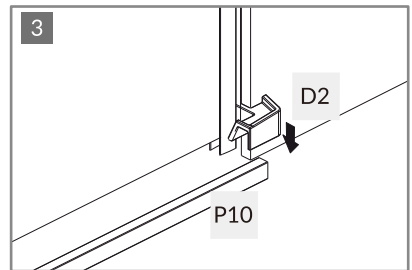
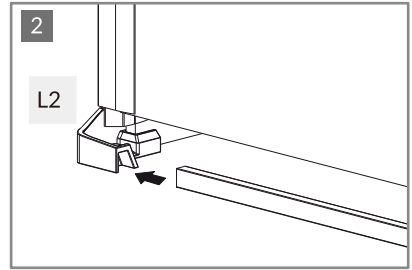
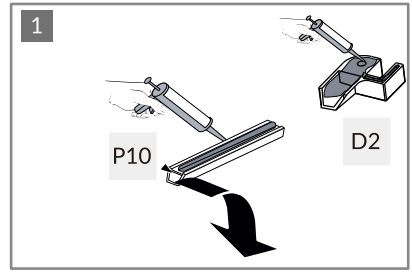
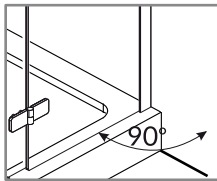
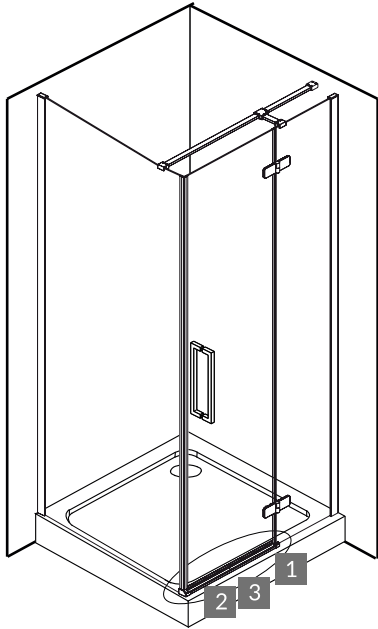
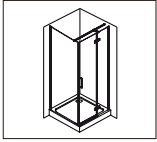

P10



x1

D2



x1



39.

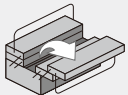
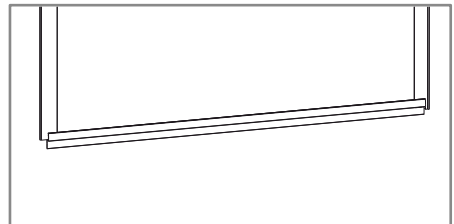
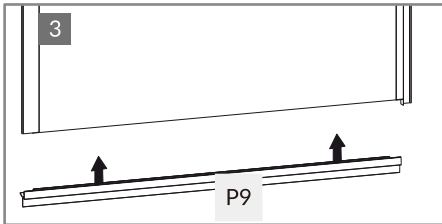
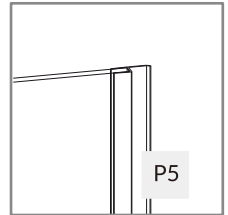
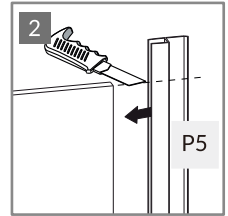
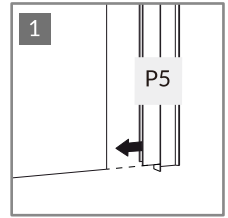
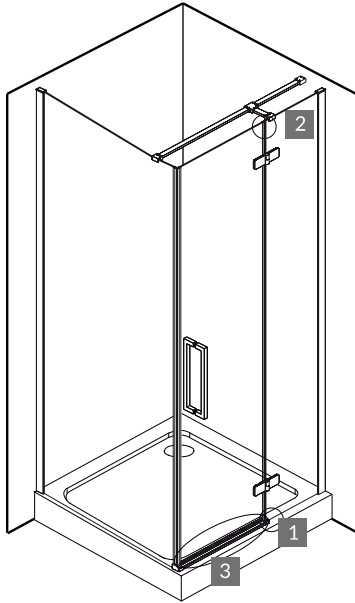
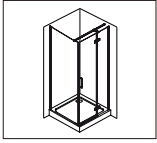

P5  x1

P9  x1



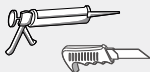
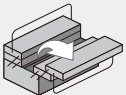
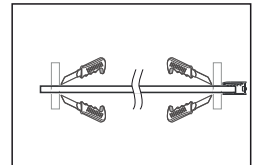
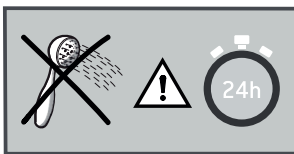
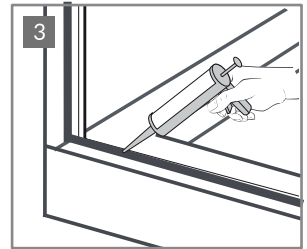
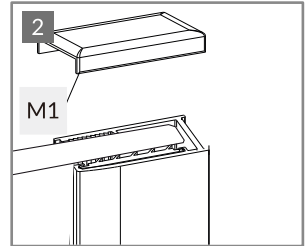
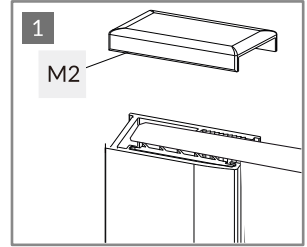
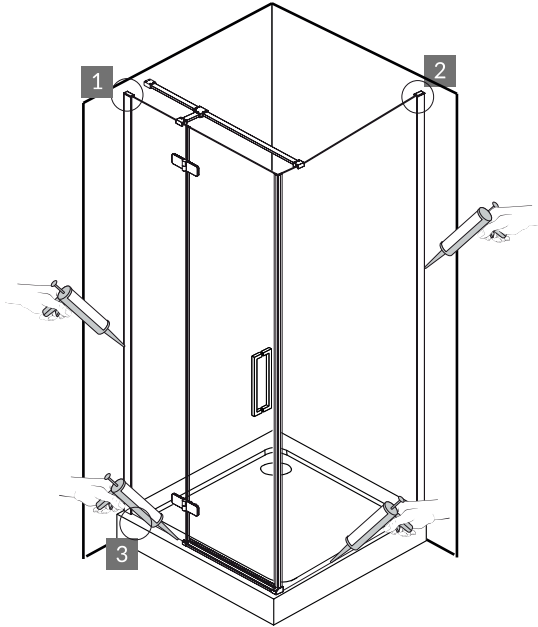
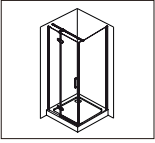

M1  x1

M2  x1





6.5<PH<7.5

